

Chromatography Solutions

# Avantor® Chromatography range

Vydac, Avantor® Alltima, Avantor® Alltima HP, Avantor® Apex,  
Avantor® Apollo, Avantor® Genesis & Avantor® Prevail



# Introduction

Avantor® manufactures a range of cutting edge HPLC chromatography products from its ISO 9001/ISO 14001 production facility.

Offering a range of high quality technical support services for free, delivered by our experienced and knowledgeable team, including column selection guidance, column lifetime advice, application support, method development and optimization strategy.

Avantor is dedicated to supplying the highest quality HPLC/UHPLC columns and other chromatography products to the scientific community. As a global leader in liquid chromatography column, manufacturing in the UK since 1978, we have gained an unrivalled reputation for high quality, competitively priced products, and fast delivery – backed up by expert technical support and after-sales service.

Hichrom Limited announced the acquisition of the global exclusive rights to manufacture Vydac®, Alltima, Alltima HP, Prevail, Apollo, Allsep, Apex, and Genesis analytical HPLC column ranges in 2016. Now part of the Avantor® family, we continue to manufacture these columns using the same exacting protocols.

---

**For more info, please contact our Chromatography Technical support team at: [chromsupport@avantorsciences.com](mailto:chromsupport@avantorsciences.com)**

# Table of contents

Avantor® HPLC columns  
for small molecules :  
Specifications  
**Page 5**

Avantor® Alltima  
for general purpose  
applications  
**Pages 6-7**

Avantor® Alltima HP  
for superior retention  
and loadability  
**Pages 8-9**

Avantor® Genesis  
for analysis of a  
wide range of analytes  
**Pages 10-11**

Avantor® Prevail  
for analysis of highly  
polar and non-polar analytes  
**Pages 12-13**

Avantor® Apex  
for traditional method  
**Page 14**

Avantor® Apollo  
for routine analysis  
**Page 15**

Vydac for biomolecules  
and polypeptide separation  
**Page 16**

Vydac TP for biomolecules  
and polypeptide separation  
**Pages 17-19**

Vydac MS for analysis of small  
peptides to large proteins  
**Pages 20-21**

Vydac Everest for high  
resolution of complex samples  
**Page 22**

Vydac Denali for small  
molecule analyses  
**Page 23**

Vydac 3021C Anion-Exchange  
for environmental analysis  
**Page 24**

Avantor® HPLC columns  
for Ion chromatography  
**Page 25**

Avantor® Allsep Anion  
for applications of anions,  
acid ions, metal complexes  
and organic acids  
**Page 26**

Avantor® Hichrom Anion/S  
for non-suppressed  
conductivity detection and  
routine separations  
**Page 27**

Avantor® Hichrom  
pre-saturation columns  
**Page 27**

Avantor® Hichrom  
Organic Acid for  
separation of organic acids  
**Page 28**

Avantor® Hichrom  
Anion Exclusion  
for separation of organic  
acids and ionised anions  
**Page 29**

Avantor® Hichrom  
Carbohydrate Cation  
for separations using  
only water  
**Page 30**

Guard cartridge systems  
**Page 31**

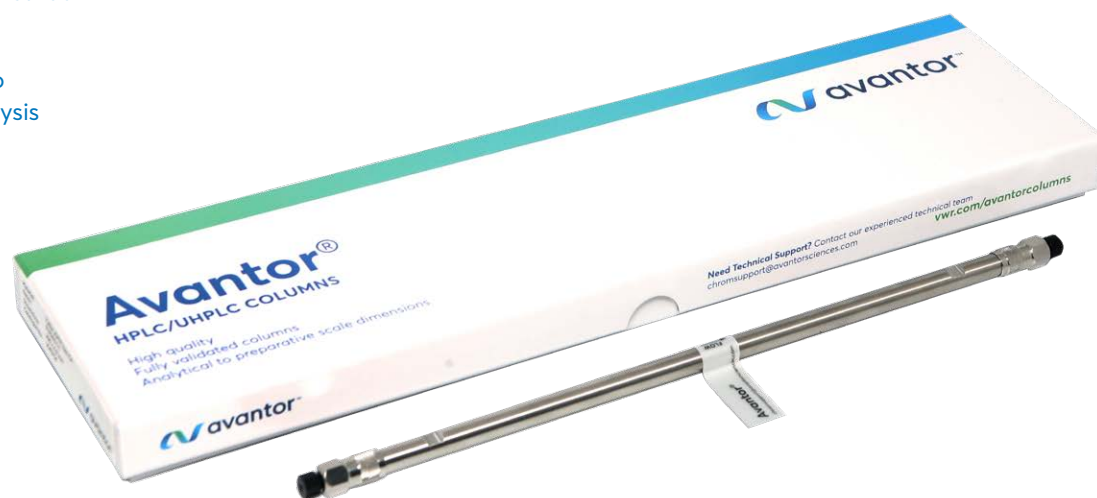





VWR  
HITACHI  
Chromaster  
5410  
UV Detector

# Avantor® HPLC columns

## for small molecules : Specifications

Phase	USP listing	Functional group	Endcapped	Particle Size (µm)	Surface Area (m <sup>2</sup> /g)	Pore size (Å)	Carbon load (%)	Bonding type	pH
<b>Avantor® Alltima</b>									
C18	L1	Octadecyl	Yes	3, 5, 10	340	100	18	Polymeric	2 – 8
C18-LL	L1	Octadecyl	Yes	5	340	100	9	Polymeric	2 – 8
C8	L7	Octyl	Yes	3, 5	340	100	6	Polymeric	2 – 8
Amino	L8	Amino	No	3, 5	340	100	-	Polymeric	2 – 8
Cyano	L10	Cyano	Yes	3, 5	340	100	-	Polymeric	2 – 8
Phenyl	L11	Phenyl	Yes	3, 5	340	100	-	Polymeric	2 – 8
Silica	L3	unbonded	-	3, 5, 10	340	100	-	-	2 – 8
<b>Avantor® Alltima HP</b>									
C18	L1	Octadecyl	Yes	3, 5	200	190	12	Monomeric	1 - 10
C18-EPS	L1	Octadecyl	Yes	3, 5	200	190	4	Monomeric	1 - 10
C18-HiLoad	L1	Octadecyl	Yes	3, 5	450	100	24	Monomeric	1 - 10
C18-AQ	L1	Octadecyl	Yes	3, 5	450	100	20	Monomeric	1 - 10
C18-Amide	L1	Octadecyl with polar-embedded amide	Yes	3, 5	200	190	12	Monomeric	1 - 10
C8	L7	Octyl	Yes	3, 5	200	190	8	Monomeric	1 - 10
Cyano	L10	Cyano	Yes	3, 5	200	190	4	Monomeric	1 - 10
Silica	L3	Unbonded	-	3, 5	450	100	-	-	2 – 8
HILIC	L3	Proprietary	-	3, 5	230	120	-	-	2 – 8
<b>Avantor® Genesis</b>									
C18	L1	Octadecyl	Yes	3, 4, 5	300	120	18	Monomeric	1 - 10
C8	L7	Octyl	No	4, 5	300	120	11	Monomeric	1 – 10
C8 (EC)	L7	Octyl	Yes	4	300	120	11	Monomeric	1 – 8
AQ	-	Proprietary	Yes	4	300	120	15	Monomeric	1 – 10
Phenyl	L11	Phenyl	Yes	4, 5	300	120	9.4	Monomeric	2 – 8
Cyano	L10	Cyano	Yes	4	300	120	7	Monomeric	2 – 8
Silica	L3	Unbonded	-	4	300	120	-	-	2 – 8
<b>Avantor® Prevail</b>									
C18	L1	Octadecyl	Yes	3, 5	350	110	15	Monomeric	2 - 8
C18-Select	L1	Octadecyl	Yes	3, 5	350	110	17	Monomeric	2 - 8
C8	L7	Octyl	Yes	5	350	110	8	Monomeric	2 - 8
Phenyl	L11	Phenyl	Yes	5	350	110	7	Monomeric	2 - 8
Cyano	L10	Cyano	Yes	3, 5	350	110	-	Monomeric	2 - 8
Amino	L8	Amino	Yes	3, 5	350	110	-	Monomeric	2 - 8
Amide	-	Proprietary polar embedded phase	No	3, 5	350	110	-	Monomeric	2 - 8
Silica	L3	Unbonded	-	5	350	110	-	-	2 - 8
Organic Acid	-	Proprietary phase	Yes	3, 5	350	110	-	Monomeric	2 - 8
<b>Avantor® Apex</b>									
ODS	L1	Octadecyl	Yes	5, 10	170	100	10	Polymeric	2 – 8
Silica	L3	Unbonded	-	3, 5	170	100	-	-	2 – 8
II Amino	L8	Amino	No	3	170	100	2	Monomeric	2 – 8
<b>Avantor® Apollo</b>									
C18	L1	Octadecyl	Yes	5	340	100	15	Monomeric	1.5 – 10.5
C8	L7	Octyl	Yes	5	340	100	9	Monomeric	1.5 – 10.5
Phenyl	L11	Phenyl	Yes	5	340	100	8	Monomeric	2 – 8
Silica	L3	Unbonded	-	5	340	100	-	-	2 – 8

Please contact [chromsupport@avantorsciences.com](mailto:chromsupport@avantorsciences.com) for advice on column selection for EP (European Pharmacopoeia) and JP (Japanese Pharmacopoeia) guidelines, or by application.

# Avantor® Alltima

## for general purpose applications

Avantor® Alltima phases are acid and base-deactivated, giving excellent peak shape for acids, bases, and neutrals in a single run. Polymerically bonded and double-endcapped for long column lifetimes, Avantor® Alltima columns are great general purpose "workhorse" columns.

### Key Features

- Base deactivated silica
- Stable bonding for long column lifetime
- Symmetrical peak shape

### AVANTOR® ALLTIMA PHASE SPECIFICATIONS

Phase	Particle size (µm)	Endcapped	Properties	Applications	USP Code
C18	3, 5, 10	Yes	Classic reversed-phase retention and selectivity	High quality hydrophobic general purpose C18	L1
C18-LL	5	Yes	Lower carbon load than traditional Alltima C18	Reversed-phase applications that require a less hydrophobic C18 phase	L1
C8	3, 5	Yes	Lower retention compared to C18 phases	Reversed-phase applications where C18 is too retentive	L7
Amino	3, 5	No	General purpose amino suitable for normal or reversed-phase use	Use for carbohydrate analysis or as a weak anion exchanger	L8
Cyano	3, 5	Yes	General purpose cyano suitable for normal or reversed-phase use	Rugged normal-phase applications	L10
Phenyl	3, 5	Yes	Less hydrophobic than C18 phase	Selective to aromatic compounds	L11
Silica	3, 5, 10	-	Highly polar phase	General purpose normal phase applications	L3

### ORDERING INFORMATION

#### ANALYTICAL COLUMNS - 3 µm

Length (mm)	20		50		100	
	2.1	4.6	2.1	4.6	1.0	2.1
i.d. (mm)						
C18	43803	43851	88353	81412	43853	88352
C8	-	-	-	81413	-	-
Amino	-	-	-	81180	-	-
Cyano	-	-	-	81179	-	-
Phenyl	-	-	-	81178	-	-
Silica	-	-	-	81414	-	-

Length (mm)	150		250	Guard cartridges (3/pk) <sup>1</sup>
	2.1	3.0	4.6	
i.d. (mm)				
C18	43852	81143	81387	AL-3C18-250D
C8	-	-	81397	-
Amino	AL-3NH-150DK <sup>2</sup>	-	81190	-
Cyano	-	-	81189	-
Phenyl	43813	-	81188	-
Silica	43884	-	81409	-

<sup>1</sup> To be used with All-Guard cartridge holder (80101/N) and column coupler for All-Guard cartridges (HI-081).  
<sup>2</sup> Actual dimensions: 150 x 2.0 mm

#### COLUMNS COMPATIBLE WITH WATERS INSTRUMENTS - 3 µm

Length (mm)	100	150
i.d. (mm)	4.6	4.6
C18	81383	81388
C8	81393	81398
Silica	81405	81410

#### ROCKET COLUMNS - 3 µm

Length (mm)	33	53
i.d. (mm) <td>7</td> <td>7</td>	7	7
C18	50603	50605
C8	-	50609
Phenyl	-	43867
Silica	-	43877

Rocket columns are specifically designed for high-throughput and high-speed methods.

### CONDITIONS

**Column:** Avantor® Alltima C8, 5 µm, 150 x 4.6 mm (p/n 88072)  
**Mobile phase:** A: 0.05 M K<sub>2</sub>HPO<sub>4</sub>, pH 3.3  
 B: Methanol  
 C: Acetonitrile  
**Gradient:** Time / min 0 2 5  
 % A 80 80 45  
 % B 10 10 30  
 % C 10 10 25  
**Flow rate:** 2.0 ml min<sup>-1</sup>  
**Detector:** UV at 280 nm

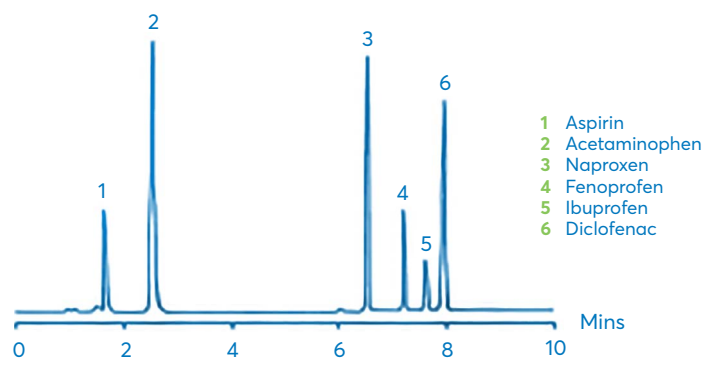

FIGURE 1: Analgesics.

**ANALYTICAL COLUMNS - 5 µm**

Length (mm)	50		100		125	150		
i.d. (mm)	2.1	4.6	3.0	4.6	4.0	2.1	3.0	4.6
C18	88888	88889	-	88059	AL-5C18-125DF	88370	81140	88052 <sup>1</sup>
C18-LL	-	-	-	-	-	88388	-	88069
C8	-	-	AL-5C8-100DT	-	-	88372	81146	88072
Amino	-	-	-	-	-	-	-	88205
Cyano	-	-	-	88065	-	-	-	88180
Phenyl	-	-	-	-	-	-	81147	88087
Silica	-	-	-	-	-	-	-	88123

<sup>1</sup> Also available in PEEK metal-free hardware (88051).

Length (mm)	250				300			Guard cartridges (3/pk) <sup>1</sup>	
i.d. (mm)	2.1	3.0	4.0	4.6	3.9	4.0	4.6	For 2.1	For 3.0-4.6
C18	88371	81142	AL-5C18-250DF	88056 <sup>2</sup>	AL-5C18-300DE	AL-5C18-300DF	AL-5C18-300D	96680/N <sup>3</sup>	96080/N <sup>4</sup>
C18-LL	88389	-	-	88099	-	-	-	96432/N	96285/N
C8	-	-	-	88076	-	-	-	96441/N	96081/N
Amino	-	-	AL-5NH-250DF	88217 <sup>5</sup>	-	-	-	-	96085/N
Cyano	-	-	-	88189	-	-	-	-	96084/N
Phenyl	-	-	-	88092	AL-5PH-300DE	-	-	96442/N	96082/N
Silica	-	-	AL-5-250DF	88171	-	AL-5-300DF	-	96450/N	96083/N

<sup>1</sup> To be used with All-Guard cartridge holder (80101/N) and column coupler for All-Guard cartridges (HI-081).  
<sup>2</sup> Also available in PEEK metal-free hardware (88055).  
<sup>3</sup> Also available with 10/pk (5174010/N).  
<sup>4</sup> Also available with 10/pk (96080SP/N).  
<sup>5</sup> Also available with reversed-phase solvent (88217RP).

**COLUMNS COMPATIBLE WITH WATERS INSTRUMENTS - 5 µm**

Length (mm)	150	250	Guard cartridges (3/pk) <sup>1</sup>
i.d. (mm)	4.6	4.6	
C18	88053	88057	96361/N
C8	88073	88077	96362/N
Amino	-	88218	96085/N
Cyano	88182	88191	96084/N
Phenyl	88088	88093	96082/N
Silica	-	88172	96083/N

<sup>1</sup> To be used with All-Guard cartridge holder (80101/N) and column coupler for All-Guard cartridges (Waters type column port: HI-881).

**METHOD VALIDATION KITS**

Alltima C18 method validation kits containing 3 columns from 3 different silica batches are available for you to evaluate the robustness of your method to ensure reproducibility run after run. Please contact us for further information.

**SEMI-PREPARATIVE AND PREPARATIVE COLUMNS - 5 µm**

Length (mm)	150		250		Guard cartridges (3/pk) <sup>1</sup>
i.d. (mm)	10	22	10	22	For 10-22
C18	81102	81106	88063	81105	AL-5C18-10CP2
C8	81109	-	88081	81110	-
Silica	81117	-	81116	81118	-

<sup>1</sup> To be used with semi-prep guard holder (C-1000) and column coupler for All-Guard cartridges (HI-081).

**SEMI-PREPARATIVE AND PREPARATIVE COLUMNS - 10 µm**

Length (mm)	250		Guard column (mm)
i.d. (mm)	10	22	33 x 7
C18	88334	88335	970203
Silica	88338	88339	970204

**CONDITIONS**

**Column:** Avantor® Alltima C18, 3 µm, 53 x 7 mm Rocket (p/n: 50605)  
**Mobile phase:** A: 0.1 % Trifluoroacetic Acid in 0.025 M Ammonium Acetate  
 B: 0.1 % Trifluoroacetic Acid in Acetonitrile  
**Gradient:**  
 Time / min    0    4  
 % A            80   5  
 % B            20   95  
**Flow rate:** 3.5 ml min  
**Detector:** UV at 254 nm

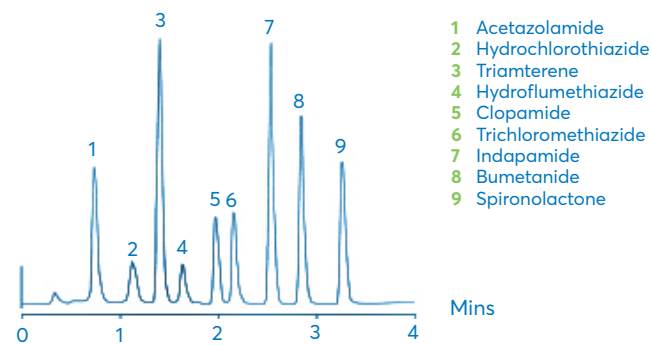

FIGURE 2: Diuretics – High Throughput.

# Avantor® Alltima HP

## for superior retention and loadability

Avantor® Alltima HP columns offer a range of different phase chemistries based on high purity silica. The Avantor® Alltima HP product family combines the selectivity and performance needed to overcome the most challenging separation needs. The low column bleed makes these columns ideal for microbore applications.

### Key Features

- High purity silica
- Excellent column stability
- Low to no detectable column bleed
- pH stability from 1 to 10
- Multiple selectivity options

### AVANTOR® ALLTIMA HP PHASE SPECIFICATIONS

Phase	Particle size (µm)	Endcapped	Properties	Applications	USP Code
C18	3, 5	Yes	Classic reversed-phase retention and selectivity	Routine applications	L1
C18-EPS	3, 5	Yes	Greater retention and enhanced peak symmetry for polar compounds. Alternative selectivity to traditional reversed-phase	Reversed-phase applications where C18 is too retentive	L1
C18-HiLoad	3, 5	Yes	Highest carbon load for superior retention and loadability	High resolution for complex samples	L1
C18-AQ	3, 5	Yes	100% water wettable	Applications requiring high aqueous mobile phases	L1
C18-Amide	3, 5	Yes	Polar-embedded phase with extremely low bleed. Compatible with microbore	Basic compounds in neutral to alkaline pH, MS applications	L1
C8	3, 5	Yes	Lower retention compared to C18 phases	Reversed-phase applications where C18 is too retentive	L7
Cyano	3, 5	Yes	Extremely stable, long life and reproducible	Ideal for basic drug analysis	L10
Silica	3, 5	No	Highly polar phase	General purpose normal phase applications	L3
HILIC	3, 5	-	Hydrophilic Interaction Chromatography uses small amounts of water for increased sensitivity with microbore applications	Very polar analytes that are difficult to retain by reversed-phase	L3

### ORDERING INFORMATION

#### CAPILLARY COLUMNS - 3 µm

Length (mm)	50	100	150
i.d. (mm)	0.3	0.3	0.3
C18	22156	22157	22158
C18-HiLoad	22193	22194	22195
C18-AQ	22563	22564	22565
C18-Amide	22258	22259	22260
C8	22482	22483	22484
HILIC	22518	22519	22520

#### CAPILLARY COLUMNS - 5 µm

Length (mm)	50	100	150	250
i.d. (mm)	0.3	0.3	0.3	0.3
C18	22128	22129	22130	22131
C18-HiLoad	22173	22174	22175	22176
C18-AQ	22535	22536	22537	22538
C18-Amide	22240	22241	22242	22243
C8	22464	22465	22466	22467
HILIC	22500	22501	22502	22503

#### ANALYTICAL COLUMNS - 3 µm

Length (mm)	20		50	
i.d. (mm)	2.1	4.6	2.1	4.6
C18	87674	87676	87504	87826
C18-EPS	87710	-	87508	87833
C18-HiLoad	87692	87694	87506	87827
C18-AQ	-	87816	-	87832
C18-Amide	87728	-	87510	87829
C8	87746	-	87512	-
Cyano	-	-	87514	87825
Silica	-	-	-	87831
HILIC	-	-	86461	-

Length (mm)	100				150			
i.d. (mm)	1.0	2.1	3.0	4.6	1.0	2.1	3.0	4.6
C18	22163	87669	87629	87667	22164	87670	87601	87668
C18-EPS	-	87705	-	87703	-	87706	87604	87704
C18-HiLoad	22230	87687	-	87685	22231	87688	87610	87686
C18-AQ	22570	87809	-	87807	22571	87810	-	87808
C18-Amide	22265	87723	-	87721	22266	87724	87607	87722
C8	22490	87741	-	87739	22491	87742	87613	87740
Cyano	-	-	-	-	-	87760	87616	87758
Silica	-	-	-	-	-	87788	87619	87786
HILIC	22525	-	-	-	22526	86463	-	86462





ANALYTICAL COLUMNS - 5 µm

Length (mm)	50			100				150				250				Guard cartridges (3/µk) <sup>1</sup>	
i.d. (mm)	4.6	1.0	2.1	1.0	2.1	3.0	4.6	1.0	2.1	3.0	4.6	1.0	2.1	3.0	4.6	For 2.1	For 3.0-4.6
C18	87643	22137	87665	22138	87681	87602	87679	22139	87682	87603	87680	87683/N	87684/N				
C18-EPS	-	-	-	-	87717	-	87715	-	87718	87606	87716	87719/N	87623/N				
C18-HiLoad	-	22183	-	22184	87699	87611	87697	22185	87700	87612	87698	87701/N	87624/N				
C18-AQ	-	22544	-	22545	87821	-	87819	22546	87822	-	87820	87823/N	87824/N				
C18-Amide	-	22249	-	22250	87735	87608	87733	22251	87736	87609	87734	87737/N	87625/N				
C8	-	22473	-	22474	87753	87614	87751	22475	-	87615	87752	87755/N	87756/N				
Cyano	-	-	-	-	87781	-	87769	-	-	87618	87780 <sup>2</sup>	87783/N	87784/N				
Silica	-	-	-	-	87799	87620	87797	-	87802	87621	87798	87803/N	87804/N				
HILIC	-	22509	-	22510	86465	-	86464	22511	-	-	86466	86479/N	86480/N				

<sup>1</sup> To be used with All-Guard cartridge holder (80101/N) and column coupler for All-Guard cartridges (HI-081).  
<sup>2</sup> Also available with reversed-phase shipping solvent (87780R).

Rocket columns are specifically designed for high-throughput and high-speed methods.

ROCKET COLUMNS - 3 µm

Length (mm)	33	53
i.d. (mm)	7	7
C18	87671	87672
C18-EPS	-	87708
C18-HiLoad	-	87690
C18-AQ	87811	87812
C8	-	87744
Cyano	87761	87762
Silica	87789	87790
HILIC	86469	86470

For additional support, please contact:  
[chromsupport@avantorsciences.com](mailto:chromsupport@avantorsciences.com)

CONDITIONS

**Column:** Avantor® Alltima HP C18-EPS, 5 µm, 150 x 4.6 mm (p/n: 87715)  
**Mobile:** A: 0.03 M Potassium Phosphate, pH 3.2  
 B: Acetonitrile  
**phase:**  
**Gradient:** Time / min 0 2 20  
 % A 95 95 70  
 % B 5 5 30  
**Flow rate:** 1.0 ml min  
**Detector:** UV at 260 nm

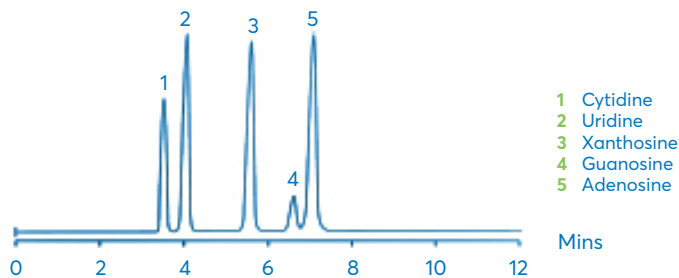

FIGURE 3: Nucleosides.

# Avantor® Genesis

## for analysis of a wide range of analytes

Avantor® Genesis phases are based on high purity, metal-free, spherical silica. They are suitable for the analysis of a wide range of compounds. Offering a more unique 4 µm particle size.

### Key Features

- Good peak shape and reproducibility
- Long column lifetime
- pH stability 1 to 10

### AVANTOR® GENESIS PHASE SPECIFICATIONS

Phase	Particle size (µm)	Endcapped	Properties	USP Code
C18	3, 4, 5	Yes	Excellent peak symmetry, reduced need for mobile phase modifiers, long column life	L1
C8	4, 5	No	Suitable for lower pH separations	L7
C8(EC)	4	Yes	Excellent peak symmetry, reduced need for mobile phase modifiers, long column life	L7
AQ	4	Yes	Designed for separating hydrophilic and polar compounds, stable retention times in 100 % aqueous mobile phases, rapid equilibration, unique reversed-phase selectivity	L1
Phenyl	4, 5	Yes	Reversed-phase chemistry, improves the chromatography of polar aromatics, fatty acids, and basic pharmaceuticals	L11
Cyano	4	Yes	Suitable for polar analysis, analytes with double- and/or triple-bonds, and compounds that have too much retention on alkyl phases	L10
Silica	4	-	Highly polar phase for general purpose applications	L3

### ORDERING INFORMATION

#### ANALYTICAL COLUMNS - 3 µm

Length (mm)	50		100		150		250	
i.d. (mm)	3.0	4.6	4.0	4.6	2.1	4.6	3.0	4.6
C18	FL5963E	FM5963E	FH10963E	FM10963E	FK15963E	FM15963E	FL25963E	FM25963E

#### ANALYTICAL COLUMNS - 4 µm

Length (mm)	30		50			100			125	
i.d. (mm)	2.1	3.0	2.1	3.0	4.6	2.1	3.0	4.6	4.0	4.6
C18	FK3960E	-	FK5960E	FL5960E	FM5960E	FK10960E	FL10960E	FM10960E	GEN-4C18-125DF	GEN-4C18-125D
C8	-	FL3962E	FK5962E	-	-	-	FL10962E	FM10962E	-	-
C8(EC)	-	-	FK5964E	-	FM5964	-	-	FM10964E	-	-
AQ	-	-	-	-	FM5951E	-	-	FM10951E	-	-
Cyano	-	-	-	-	-	-	-	FM10965E <sup>1</sup>	-	-

<sup>1</sup> Also available in PEEK, metal-free column hardware (FM10965EP).

Length (mm)	150			250			Guard cartridges (3/pk) <sup>1</sup>
i.d. (mm)	4.0	4.6	3.0	4.0	4.6	4.6	For 3.0-4.6
C18	FH15960E	FM15960E	FL25960E	FH25960E	FM25960E	FM25960E	FH1960-2/N
C8	-	FM15962E	-	-	FM25962E	FM25962E	FH1962-2/N
C8(EC)	-	FM15964E	-	FH25964E	FM25964E	FM25964E	-
AQ	-	FM15951E	-	-	FM25951E	FM25951E	FH1951-2/N
Cyano	-	FM15965E <sup>2</sup>	-	-	FM25965E	FM25965E	-
Phenyl	-	FM15980E	-	-	FM25980E	FM25980E	-
Silica	-	-	-	-	FM25961E	FM25961E	FH1961-2/N

<sup>1</sup> To be used with All-Guard cartridge holder (80101/N) and column coupler for All-Guard cartridges (HI-081).

<sup>2</sup> Also available with reversed-phase shipping solvent (FM15965ER).

ANALYTICAL COLUMNS - 5 µm

Length (mm)	125	150	250
i.d. (mm)	4.6	4.6	4.6
C18	GEN-5C18-125D	GEN-5C18-150D	GEN-5C18-250D
C8	-	-	GEN-5C8-250D
Phenyl	-	-	GEN-5PH-250D

SEMI-PREPARATIVE AND PREPARATIVE COLUMNS - 4 µm

Length (mm)	150	250
i.d. (mm)	10	10
C18	-	8P25960
Silica	8P15961	-

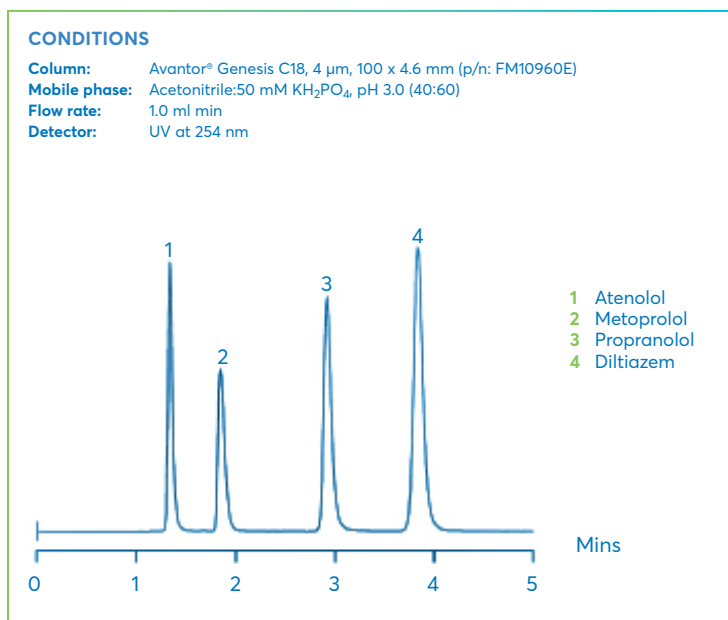

FIGURE 4: Anti-Anginal Drugs.

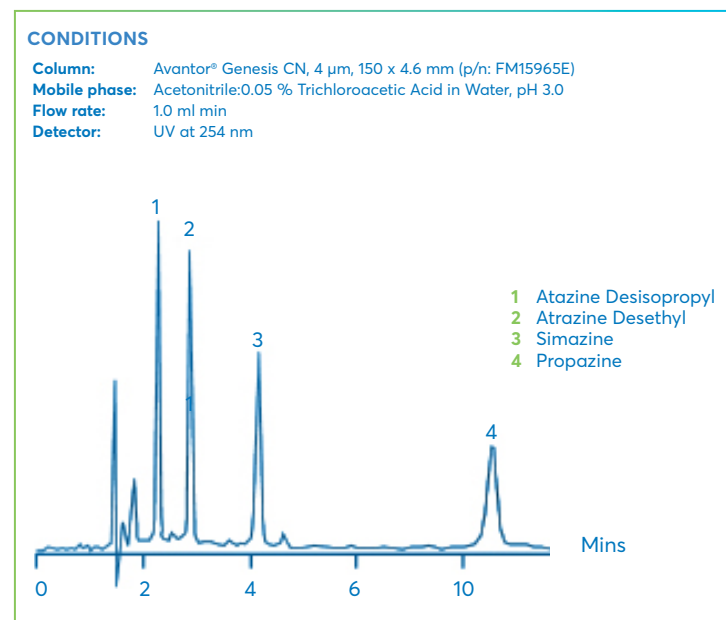

FIGURE 5: Atrazine Herbicides.

# Avantor® Prevail

## for analysis of highly polar and non-polar analytes

Avantor® Prevail range exhibits long lifetimes in both highly aqueous and highly organic mobile phases. The stability of these phases is such that a single column can be switched between highly aqueous, for analysis of highly polar analytes, and highly organic, for strong retention of hydrophobic analytes.

### Key Features

- Stable from highly organic to highly aqueous
- Speciality phases for specific applications
- Excellent sensitivity with microbore and ELSD applications

### AVANTOR® PREVAIL PHASE SPECIFICATIONS

Phase	Particle size (µm)	Properties	Applications	USP Code
C18	3, 5	Stable in highly aqueous to highly organic mobile phases	Flexibility to switch between varied mobile phase conditions to suit a variety of applications. Excellent sensitivity for microbore applications	L1
C18-Select	3, 5	Stable in highly aqueous to highly organic mobile phases	Suitable for applications where greater retention than the Prevail C18 is required	L1
C8	5	Stable C8 phase	Use for highly hydrophobic compounds that retain too strongly on C18	L7
Phenyl	5	Lowest hydrophobic capacity	Selective for aromatic compounds in a variety of mobile phase conditions	L11
Cyano	3, 5	General purpose cyano suitable for normal or reversed-phase use	Rugged normal phase applications	L10
Amino	3, 5	Stable in highly aqueous to highly organic mobile phases	Use for carbohydrates or as a weak anion exchanger	L8
Amide	5	Polar embedded phase	Suitable for use with highly aqueous mobile phases	–
Silica	3, 5	Highly polar phase	General purpose normal phase applications	L3
Organic acid	3, 5	Highly efficient silica-based, acid-stable phase	Separates common organic acids with unsurpassed resolution, speed and sensitivity. Lower cost than polymeric columns	–

### Prevail Organic Acid

Prevail Organic Acid columns are silica-based for maximum efficiency and high resolution. They can separate common organic acids with a combination of speed, sensitivity, and simplicity. A simple acidic phosphate buffer and a Prevail OA column at ambient temperature will separate 11 short chain organic acids in less than 6 minutes. The retention profile can be readily adjusted by changing the mobile phase pH.

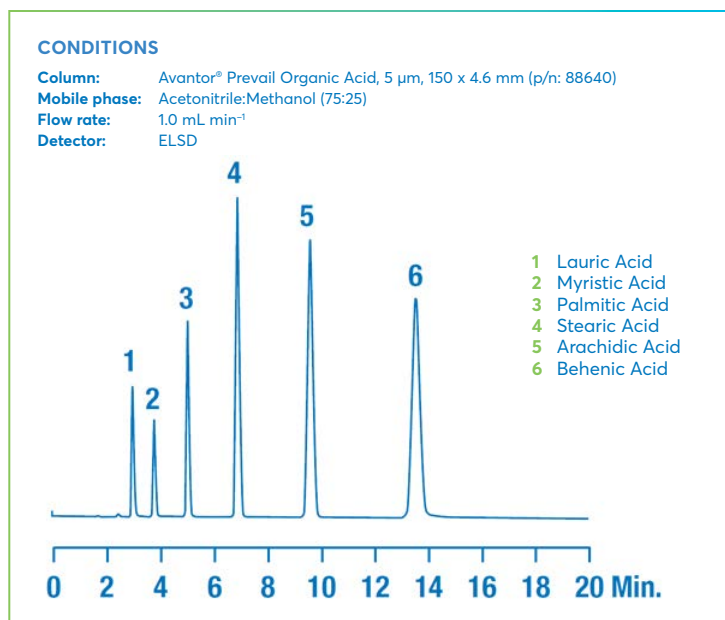

FIGURE 6: Underivatized Fatty Acids.

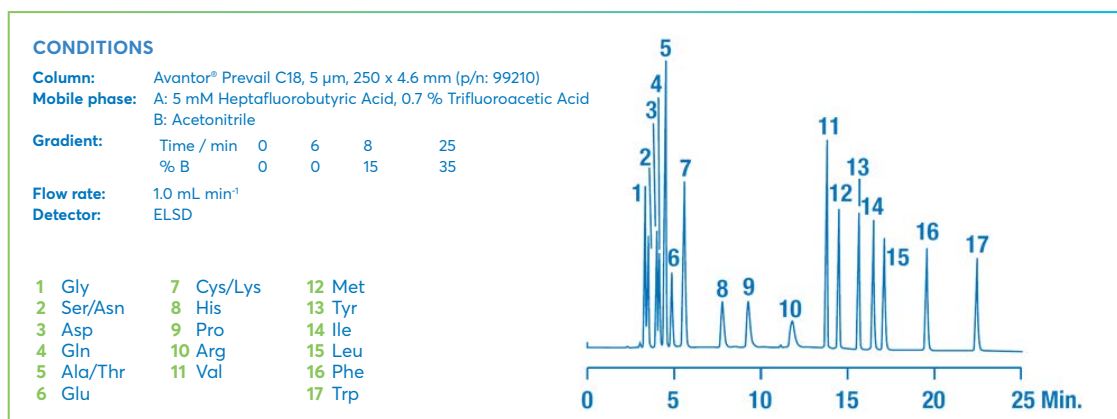

FIGURE 7: Amino Acids without Derivatization.

**ORDERING INFORMATION**

**ANALYTICAL COLUMNS - 3 µm**

Length (mm)	20		50		100		150			Guard cartridges (3/pk) <sup>1</sup>
i.d. (mm)	2.1	2.1	4.6	2.1	4.6	2.1	3.0	4.6	For 2.1	
C18	43827	43818	43829	43871	99202	99200	99322	99204	96683/N	
C18-Select	-	99309	-	99312	99302	99313	99315	99303	96691/N	
Cyano	-	-	-	-	-	99243	-	99247	-	
Amino	-	-	-	-	99257	99255	-	99259	-	
Silica	-	-	-	43805	-	-	99341	99271	-	
Organic acid	-	-	-	88648	-	-	-	88655	-	

<sup>1</sup> To be used with All-Guard cartridge holder (80101/N) and column coupler (HI-081).

**ROCKET COLUMNS - 3 µm**

Length (mm)	33	53
i.d. (mm)	7	7
C18	99280	99279
C18-Select	99304	99305
Organic Acid	-	50755

**ANALYTICAL COLUMNS - 5 µm**

Length (mm)	50	100	125	150			250		Guard cartridges (3/pk) <sup>1</sup>	
i.d. (mm)	4.6	4.6	4.6	2.1	3.0	4.6	3.0	4.6	For 2.1	For 3.0-4.6
C18	43903	-	PRE-5C18-125D	99206	99320	99208	99321	99210	96682/N	99286/N
C18-Select	-	-	-	-	99316	99300	99317	99301	96690/N	99119/N
C8	-	-	-	99218	-	99224	5131428	99229	99128/N	99287/N
Phenyl	-	-	-	99237	99326	99239	99327	99241	99130/N	99288/N
Cyano	-	-	-	-	99329	99251	-	99253	99131/N	99353/N
Amino	-	-	-	99261	-	99263	-	99265	99135/N	99290/N
Amide	-	PRE-5AM-100D	-	-	-	88660	-	88665	-	-
Silica	-	-	-	99273	99339	99275	99340	99277	99133/N	99354/N
Organic acid	-	-	-	-	-	88640	PRE-5OA-250DT	88645	-	96429/N

<sup>1</sup> To be used with All-Guard cartridge holder (80101/N) and column coupler for All-Guard cartridges (HI-081).

**COLUMNS COMPATIBLE WITH WATERS INSTRUMENTS - 5 µm**

Length (mm)	150	250	Guard cartridges (3/pk) <sup>1</sup>
i.d. (mm)	4.6	4.6	For 3.0-4.6
C18	99209	99211	99286/N
Organic Acid	88740	88745	96429/N

<sup>1</sup> To be used with All-Guard cartridge holder (80101/N) and column coupler for All-Guard cartridges (Waters type column port: HI-881).

**SEMI-PREPARATIVE AND PREPARATIVE COLUMNS - 5 µm**

Length (mm)	150	250		Guard column (mm)
i.d. (mm)	22	10	22	33 x 7
C18	99296	99294	99297	970211



# Avantor<sup>®</sup> Apex

## for traditional methods

Avantor<sup>®</sup> Apex are an economical range of columns manufactured using traditional silica. These columns are recommended for routine analysis and legacy methods.

### Key Features

- Conventional 100 Å pore size spherical silica
- Narrow particle size distribution
- Controlled surface area

#### AVANTOR<sup>®</sup> APEX AND APEX II SPECIFICATIONS

Phase	Particle size (µm)	Endcapped	USP Code
ODS	5, 10	Yes	L1
Silica	3, 5	-	L3
Amino II	3	No	L8

#### ORDERING INFORMATION

##### ANALYTICAL COLUMNS - 3 µm

Length (mm)	150
i.d. (mm)	4.6
Silica	4M15303
Amino II	4M15344

##### ANALYTICAL COLUMNS - 5 µm

Length (mm)	30	50	100	150	250	Guard cartridges (3/pk) <sup>1</sup>
i.d. (mm)	4.6	4.6	4.6	4.6	4.6	For 3.0-4.6
ODS	4M3310P	4M5310	4M10310	4M15310	4M25310	FH1310-2/N
Silica	-	-	-	-	4M25300	FH1300-2/N

<sup>1</sup> To be used with All-Guard cartridge holder (80101/N) and column coupler for All-Guard cartridges (HI-081).



# Avantor® Apollo

## for routine analysis

Avantor® Apollo HPLC columns are based on high purity, base deactivated silica for powerful separations at an economical price. They are ideal for routine analysis in educational laboratories.

### AVANTOR® APOLLO PHASE SPECIFICATIONS

Phase	Particle size (µm)	Endcapped	USP Code
C18	5	Yes	L1
C8	5	Yes	L7
Phenyl	5	Yes	L11
Silica	5	-	L3

### ORDERING INFORMATION

#### ANALYTICAL COLUMNS - 5 µm

Length (mm)	150		250	Guard cartridges (3/pk) <sup>1</sup>
i.d. (mm)	3.9	4.6	4.6	For 3.0-4.6
C18	AP-5C18-150DE	36505	36511	96454/N
C8	-	36506	36512	96463/N
Phenyl	-	36538	36544	96430/N
Silica	-	36507	36513	96419/N

<sup>1</sup> To be used with All-Guard cartridge holder (80101/N) and column coupler for All-Guard cartridges (HI-081).

#### COLUMNS COMPATIBLE WITH WATERS INSTRUMENTS - 5 µm

Length (mm)	150	250	Guard cartridges (3/pk) <sup>1</sup>
i.d. (mm)	4.6	4.6	For 3.0-4.6
C18	36515	36521	96454/N
C8	-	5126774	96463/N
Phenyl	5126788	-	96430/N
Silica	-	36523	96419/N

<sup>1</sup> To be used with All-Guard cartridge holder (80101/N) and column coupler for All-Guard cartridges (Waters type column port: HI-881).

#### SEMI-PREPARATIVE AND PREPARATIVE COLUMNS - 5 µm

Length (mm)	150			250		Guard column (33 x 7 mm) <sup>1</sup>
i.d. (mm)	7	10	22	10	22	-
C18	36530	36531	36526	36543	36537	970205
Phenyl	-	36527	36535	36532	36528	970218
Silica	36542	-	-	-	36524	970206

<sup>1</sup> To be used with column coupler (HI-081).

### Key Features

- Easy scale-up from analytical to prep
- Extended pH stability - 1.5 to 10.5



For additional dimensions please contact  
[chromsupport@avantorsciences.com](mailto:chromsupport@avantorsciences.com)

# Vydac

## for biomolecules and polypeptide separation

Vydac 300 Å columns are a commonly employed range in bioseparations. Vydac columns are fully scalable from capillary to microbore and analytical to preparative dimensions. Separate biomolecules from small peptides to large intact proteins with the Vydac family of reversed-phase columns (including Vydac TP, MS, Denali, and Everest) and ion exchange (Vydac 302IC) columns. Reversed-phase columns for a polypeptide separation should be considered on the basis of the polypeptide's hydrophobicity, with molecular weight as a secondary consideration.

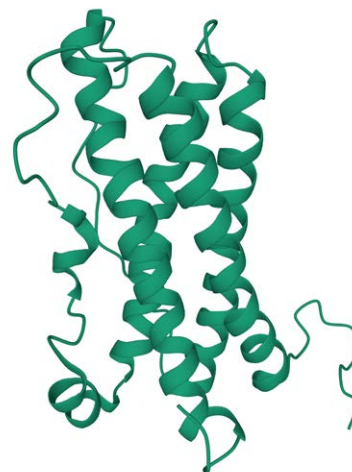

### VYDAC HPLC COLUMN SPECIFICATIONS

Phase	USP listing	Functional group	Endcapped	Particle Size (µm)	Surface Area (m <sup>2</sup> /g)	Pore size (Å)	Carbon load (%)	Bonding type	pH
<b>Vydac TP</b>									
218TP	L1	Octadecyl	Yes	3, 5, 10, 10-15, 15-20, 20-30	60 - 110	300	8	Polymeric	2 - 7
238TP	L1	Octadecyl	No	5	60 - 110	300	4	Monomeric	2 - 7
201TP	L1	Octadecyl	No	5, 10	70 - 90	300	8	Polymeric	2 - 7
202TP	L1	Octadecyl	No	5	60 - 90	300	9	Polymeric	2 - 7
208TP	L7	Octyl	Yes	3, 5, 10, 10-15, 15-20	60 - 110	300	5	Polymeric	2 - 7
214TP	L26	Butyl	Yes	3, 5, 10, 10-15, 15-20	60 - 110	300	3	Polymeric	2 - 7
214ATP	L26	Butyl	Yes	5	60 - 110	300	3	Polymeric	2 - 7
219TP	L11	Diphenyl	Yes	5, 10	60 - 110	300	4	Polymeric	2 - 7
<b>Vydac MS</b>									
218MS	L1	Octadecyl	Yes	5, 10	200	190	12	Monomeric	2 - 7
238MS	L1	Octadecyl	Yes	5	200	190	4	Monomeric	2 - 7
208MS	L1	Octadecyl	Yes	5, 10	450	100	24	Monomeric	2 - 7
214MS	L1	Octadecyl	Yes	5, 10, 10-15	450	100	20	Monomeric	2 - 7
<b>Vydac Denali</b>									
238DE	L1	Octadecyl	Yes	5, 10	70 - 110	120	6	Monomeric	2 - 7
<b>Vydac Everest</b>									
238EV	L1	Octadecyl	Yes	5	70 - 110	300	6	Monomeric	2 - 7
<b>Vydac IC</b>									
302IC	-	Quaternary amine	-	10	-	> 100	-	-	2 - 6.5

Please contact [chromsupport@avantorsciences.com](mailto:chromsupport@avantorsciences.com) for advice on column selection for EP (European Pharmacopoeia) and JP (Japanese Pharmacopoeia) guidelines, or by application.

# Vydac TP

## for biomolecules and polypeptide separation

Vydac TP reversed-phase material consists of aliphatic groups bonded to the surface of 300 Å pore diameter silica. The large pores of the TP silica give polypeptide molecules complete access to the interior of the silica pores. Vydac TP silica is the standard that has defined large pore HPLC for polypeptide separations for nearly two decades.

### Key Features

- Long column lifetime and negligible phase leaching
- Reliable protein purifications, scalable from analytical to preparative scale
- Referenced in a large number of patents and publications

### VYDAC TP PHASE SPECIFICATIONS

Phase	Particle size (µm)	Functional group	Properties	Applications	USP code
218TP	3, 5, 10	C18	First generation polymeric C18 phase with unique selectivity	Small polypeptides 4-5 kDa MW, enzymatic digest fragments, natural and synthetic peptides, multi-ring compounds	L1
238TP	5	C18	First generation monomeric C18 phase	Use for same applications as 218TP, but offers different C18 selectivity	L1
201TP	5, 10	C18	Non-encapped C18 phase	Developed for separation of PAHs	L1
202TP	5	C18	Higher carbon load than 201TP	Developed for separation of PAHs	L1
208TP	3, 5, 10	C8	Less hydrophobic than C18TP phase	Polypeptides 10-20 kDa MW	L7
214TP	5, 10	C4	First generation C4 phase	Glycoproteins, haemoglobin variants, histones, insulin variants, membrane proteins	L26
214ATP	5	C4	C4 phase with lower level of endcapping	Optimised for analysis of human growth hormone	L26
219TP	5, 10	Diphenyl	Lowest capacity first generation diphenyl phase	Polypeptides with aromatic side chains, large hydrophobic proteins, membrane-spanning peptides, lipid peptides, fusion proteins from inclusion bodies	L11

### ORDERING INFORMATION

#### CAPILLARY COLUMNS - 5 µm

Length (mm)	150	
i.d. (mm)	0.3	0.5
218TP	218TP5.315	–
214TP	214TP5.315	214TP5.515

#### ANALYTICAL COLUMNS - 3 µm

Length (mm)	50			100	
i.d. (mm)	2.1	3.0	4.6	3.0	4.6
218TP	218TP3205	218TP3305	218TP3405	–	218TP3410
208TP	–	–	208TP3405	208TP3310	208TP3410

Length (mm)	150		250	
i.d. (mm)	2.1	4.6	3.0	4.6
218TP	218TP3215	218TP3415	–	218TP34
208TP	–	–	208TP33	–

Length (mm)	Guard cartridges (2/pk) <sup>1</sup>		Guard cartridge kits <sup>2</sup>	
i.d. (mm)	For 2.1	For 3.0–4.6	For 2.1	For 3.0–4.6
218TP	218GD32/N	218GD34/N	218GK32/N	218GK34/N
208TP	–	208GD34/N	–	208GK34/N

<sup>1</sup> To be used with All-Guard cartridge holder (80101/N) and column coupler for All-Guard cartridges (HI-081).  
<sup>2</sup> Includes holder (80101/N), column coupler (HI-081), and 1 guard cartridge.



ORDERING INFORMATION

ANALYTICAL COLUMNS - 5 µm

Length (mm)	50				
i.d. (mm)	2.1	1.0	2.1	3.0	4.6
218TP	-	218TP5105	218TP5205	218TP5305	218TP5405
238TP	-	238TP5105	238TP5205	-	238TP5405
201TP	201TP5203	201TP5105	201TP5205	-	201TP5405
208TP	-	208TP5105	208TP5205	-	208TP5405
214TP	-	214TP5105	214TP5205	214TP5305	214TP5405
214ATP	-	-	-	-	214ATP5405
219TP	-	219TP5105	219TP5205	-	219TP5405

Length (mm)	100			
i.d. (mm)	1.0	2.1	3.0	4.6
218TP	218TP5110	218TP5210	-	218TP5410
238TP	238TP5110	-	-	238TP5410
201TP	-	201TP5210	201TP5310	201TP5410
208TP	208TP5110	208TP5210	-	208TP5410
214TP	214TP5110	214TP5210	214TP5310	214TP5410
214ATP	-	214ATP5210	-	-
219TP	-	219TP5210	-	219TP5410

Length (mm)	150			
i.d. (mm)	1.0	2.1	3.0	4.6
218TP	218TP5115	218TP5215	-	218TP5415
238TP	238TP5115	238TP5215	238TP5315	238TP5415
201TP	201TP5115	201TP5215	201TP5315	201TP5415
202TP	-	-	-	202TP5415
208TP	208TP5115	208TP5215	208TP5315	208TP5415
214TP	214TP5115	214TP5215	214TP5315	214TP5415
214ATP	-	214ATP5215	-	214ATP5415
219TP	219TP5115	219TP5215	219TP5315	219TP5415

Length (mm)	250				
i.d. (mm)	1.0	2.1	3.0	4.0	4.6
218TP	218TP51	218TP52	218TP53	-	218TP54
238TP	238TP51	238TP52	238TP53	-	238TP54
201TP	201TP51	201TP52	-	201TP540	201TP54
202TP	-	-	-	-	202TP54
208TP	208TP51	208TP52	208TP53	-	208TP54
214TP	214TP51	214TP52	214TP53	-	214TP54
214ATP	-	214ATP52	-	-	214ATP54
219TP	219TP51	219TP52	219TP53	-	219TP54

Length (mm)	Guard cartridges (2/pk) <sup>1</sup>			Guard cartridge kits <sup>2</sup>		
	For 1.0	For 2.1	For 3.0-4.6	For 1.0	For 2.1	For 3.0-4.6
218TP	218GD51/N	218GD52/N	218GD54/N	218GK51/N	218GK52/N	218GK54/N
238TP	238GD51/N	238GD52/N	238GD54/N	238GK51/N	238GK52/N	238GK54/N
201TP	-	201GD52/N	201GD54/N	-	201GK52/N	201GK54/N
202TP	-	-	202GD54/N	-	-	202GK54/N
208TP	208GD51/N	208GD52/N	208GD54/N	208GK51/N	208GK52/N	208GK54/N
214TP	214GD51/N	214GD52/N	214GD54/N	214GK51/N	214GK52/N	214GK54/N
214ATP	-	-	214AGD54/N	-	-	214AGK54/N
219TP	-	219GD52/N	219GD54/N	-	219GK52/N	219GK54/N

<sup>1</sup> To be used with All-Guard cartridge holder (80101/N) and column coupler for All-Guard cartridges (HI-081).  
<sup>2</sup> Includes holder (80101/N), column coupler (HI-081), and 1 guard cartridge.

ANALYTICAL COLUMNS - 10 µm

Length (mm)						Guard cartridges (2/pk) <sup>1</sup>	Guard cartridge kits <sup>2</sup>
	50	150	250				
i.d. (mm)	4.6	4.6	1.0	2.1	4.6	For 3.0-4.6	For 3.0-4.6
218TP	-	218TP10415	218TP101	218TP102	218TP104	218GD104/N	218GK104/N
201TP	-	201TP10415	-	-	201TP104	201GD104/N	201GK104/N
208TP	208TP10405	208TP10415	-	-	208TP104	208GD104/N	208GK104/N
214TP	-	214TP10415	214TP101	-	214TP104	214GD104/N	214GK104/N

<sup>1</sup> To be used with All-Guard cartridge holder (80101/N) and column coupler for All-Guard cartridges (HI-081).  
<sup>2</sup> Includes holder (80101/N), column coupler (HI-081), and 1 guard cartridge.

ANALYTICAL COLUMNS - 10-15 µm

Length (mm)	150	250
i.d. (mm)	4.6	4.6
218TP	5119751	218TP10154
214TP	-	214TP10154

CONDITIONS

**Column:** Vydac 201TP C18 (p/n 201TP5415)  
**Particle size:** 5 µm  
**Dimensions:** 150x4.6 mm  
**Mobile phase:** A: H<sub>2</sub>O - B: Acetonitrile  
**Gradient:** Time / min 0 30  
 % B 50 100  
**Flow rate:** 1.0 mL min<sup>-1</sup>

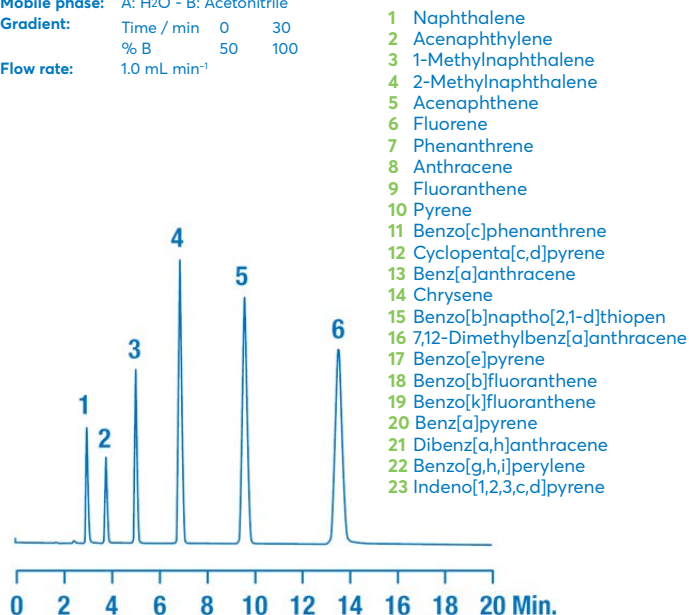

FIGURE 8: Beyond the EPA 16 Priority-Pollutant PAHs.



**ANALYTICAL COLUMNS - 15-20 µm**

Length (mm)	50	100	150	250	Guard cartridges (2/pk) <sup>1</sup>	Guard cartridge kits <sup>2</sup>
i.d. (mm)	4.6	4.6	4.6	4.6	For 3.0-4.6	For 3.0-4.6
218TP	218TP1520405	218TP1520410	218TP1520415	-	-	-
208TP	-	208TP1520410	-	-	-	-
214TP	-	-	-	214TP15204	214GD15204/N	214GK15204/N

<sup>1</sup> To be used with All-Guard cartridge holder (80101/N) and column coupler for All-Guard cartridges (HI-081).

<sup>2</sup> Includes holder (80101/N), column coupler (HI-081), and 1 guard cartridge.

**ANALYTICAL COLUMNS - 20-30 µm**

Length (mm)	150
i.d. (mm)	4.6
218TP	218TP2030415

**SEMI-PREPARATIVE AND PREPARATIVE COLUMNS - 5 µm**

Length (mm)	100		150	250	Guard cartridges (2/pk) <sup>1</sup>	Guard cartridge kits <sup>2</sup>
i.d. (mm)	10	22	10	10	For 10-22	For 10-22
218TP	218TP51010	-	218TP51015	218TP510	218GCC510	218FSK510
238TP	-	-	-	238TP510	-	-
201TP	-	-	-	201TP510	-	-
208TP	208TP51010	-	-	208TP510	208GCC510	208FSK510
214TP	214TP51010	214TP52210	214TP51015	214TP510	214GCC510	214FSK510
214ATP	-	-	-	214ATP510	-	-
219TP	-	-	-	219TP510	219GCC510	219FSK510

<sup>1</sup> To be used with semi-prep guard holder (GCH10) and column coupler for All-Guard cartridges (HI-081).

<sup>2</sup> Includes holder (GCH10), column coupler (HI-081), and 1 guard cartridge.

**SEMI-PREPARATIVE AND PREPARATIVE COLUMNS - 10 µm**

Length (mm)	100	150		250		Guard cartridges (2/pk) <sup>1</sup>
i.d. (mm)	22	10	22	10	22	For 10-22
218TP	218TP102210	218TP101015	218TP102215	218TP1010	218TP1022	218GCC1010
208TP	-	-	-	208TP1010	208TP1022	208GCC1010
214TP	-	214TP101015	214TP102215	214TP1010	214TP1022	214GCC1010
219TP	-	-	-	219TP1010	219TP1022	219GCC1010

<sup>1</sup> To be used with semi-prep guard holder (GCH10) and column coupler for All-Guard cartridges (HI-081).

**SEMI-PREPARATIVE AND PREPARATIVE COLUMNS - 10-15 µm**

Length (mm)	150		250		Guard cartridges - 12 µm (2/pk) <sup>1</sup>	Guard cartridge kits - 12 µm <sup>2</sup>
i.d. (mm)	10	22	10	22	For 10-22	For 10-22
218TP	-	-	218TP101510	218TP101522	218GCC1210	218FSK1210
208TP	-	-	208TP101510	208TP101522	208GCC1210	208FSK1210
214TP	214TP10151015	214TP10152215	214TP101510	214TP101522	214GCC1210	214FSK1210

<sup>1</sup> To be used with All-Guard cartridge holder (80101/N) and column coupler for All-Guard cartridges (HI-081).

<sup>2</sup> Includes holder (80101/N), column coupler (HI-081), and 1 guard cartridge.

**SEMI-PREPARATIVE AND PREPARATIVE COLUMNS - 15-20 µm**

Length (mm)	100	150	250		Guard cartridges (2/pk) <sup>1</sup>
i.d. (mm)	22	22	10	22	For 10-22
218TP	218TP15202210	218TP15202215	218TP152010	218TP152022	-
208TP	-	-	-	-	-
214TP	-	-	214TP152010	214TP152022	214GCC152010

<sup>1</sup> To be used with semi-prep guard holder (GCH10) and column coupler for All-Guard cartridges (HI-081).

# Vydac MS

## for analysis of small peptides to large proteins

Vydac MS is a further development of the Vydac range for reversed-phase separation of biomolecules. A proprietary surface treatment and bonding process give Vydac MS columns unique selectivity. A variety of reversed-phases makes this product line suitable for the analysis of small peptides to large intact proteins.

### Key Features

- 300 Å pore size spherical silica
- Four reversed-phase chemistries
- Excellent peak shape with little or no TFA
- High protein recoveries make scale-up easy

### VYDAC MS PHASE SPECIFICATIONS

Phase	Functional group	Particle size (µm)	Properties	Applications	USP code
218MS	C18	5, 10	Polymeric bonding, highest hydrophobic interaction and unique geometric selectivity	Use for simple enzymatic digests (<12 proteins) or biomolecules 0–5 kDa MW	L1
238MS	C18	5	Monomeric bonding offers increased peptide interaction and generally yields higher peak counts	Use for same applications as 218MS, but offers different C18 selectivity	L1
208MS	C8	5, 10	Lower hydrophobicity is better for larger biomolecules	Ideal for biomolecules 5–10 kDa MW	L7
214MS	C4	5, 10	Lower capacity than C18 or C8, suitable for hydrophobic proteins or when minimal organic solvent is desired	Ideal for biomolecules >10 kDa MW, intact proteins, antibodies, oligonucleotides, human growth hormone	L26

### ORDERING INFORMATION

#### CAPILLARY COLUMNS - 5 µm

Length (mm)	50		
i.d. (mm)	0.075	0.3	0.5
218MS	218MS5.07505	218MS5.305	218MS5.505
238MS	238MS5.07505	238MS5.305	238MS5.505
208MS	208MS5.07505	208MS5.305	208MS5.505
214MS	214MS5.07505	214MS5.305	214MS5.505

Length (mm)	100			
i.d. (mm)	0.075	0.1	0.3	0.5
218MS	218MS5.07510	–	218MS5.310	218MS5.510
238MS	238MS5.07510	–	238MS5.310	238MS5.510
208MS	208MS5.07510	208MS5.1010	208MS5.310	208MS5.510
214MS	214MS5.07510	–	214MS5.310	214MS5.510

Length (mm)	150		
i.d. (mm)	0.075	0.3	0.5
218MS	218MS5.07515	218MS5.315	218MS5.515
238MS	238MS5.07515	238MS5.315	238MS5.515
208MS	208MS5.07515	208MS5.315	208MS5.515
214MS	214MS5.07515	214MS5.315	214MS5.515

Length (mm)	250		
i.d. (mm)	0.075	0.3	0.5
218MS	218MS5.07525	218MS5.325	218MS5.525
238MS	238MS5.07525	238MS5.325	238MS5.525
208MS	208MS5.07525	208MS5.325	208MS5.525
214MS	214MS5.07525	214MS5.325	214MS5.525

#### ANALYTICAL COLUMNS - 5 µm

Length (mm)	20	50			
i.d. (mm)	2.1	4.6	1.0	2.1	4.6
218MS	218MS5202	218MS5402	218MS5105	218MS5205	218MS5405
238MS	–	–	238MS5105	238MS5205	–
208MS	–	–	208MS5105	208MS5205	–
214MS	–	–	214MS5105	214MS5205	214MS5405

Length (mm)	100			
i.d. (mm)	1.0	2.1	3.0	4.6
218MS	218MS5110	218MS5210	218MS5310	218MS5410
238MS	238MS5110	238MS5210	–	238MS5410
208MS	208MS5110	208MS5210	–	–
214MS	214MS5110	214MS5210	214MS5310	214MS5410

Length (mm)	100				200
i.d. (mm)	1.0	2.1	3.0	4.6	1.0
218MS	218MS5115	218MS5215	–	218MS5415	218MS5120
238MS	238MS5115	238MS5215	–	238MS5415	–
208MS	208MS5115	208MS5215	208MS5315	208MS5415	–
214MS	214MS5115	214MS5215	214MS5315	214MS5415	–

Length (mm)	250			
i.d. (mm)	1.0	2.1	3.0	4.6
218MS	218MS51	218MS52	218MS53	218MS54
238MS	238MS51	238MS52	–	238MS54
208MS	208MS51	208MS52	–	208MS54
214MS	214MS51	214MS52	214MS53	214MS54

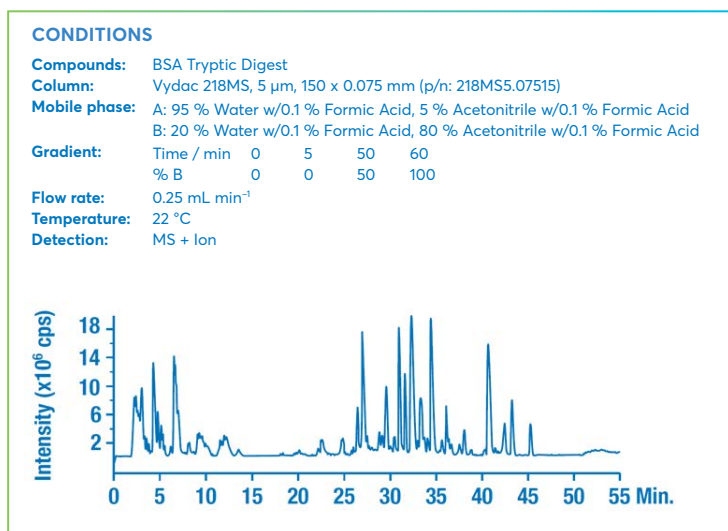

FIGURE 9: BSA Tryptic Digest.

**ANALYTICAL COLUMNS - 5 µm**

Length (mm)	Guard cartridges (2/pk) <sup>1</sup>			Guard cartridge kits <sup>2</sup>		
i.d. (mm)	For 1.0	For 2.1	For 3.0-4.6	For 1.0	For 2.1	For 3.0-4.6
218MS	218GD51MS/N	218GD52MS/N	218GD54MS/N	218GK51MS/N	218GK52MS/N	218GK54MS/N
238MS	238GD51MS/N	238GD52MS/N	238GD54MS/N	238GK51MS/N	238GK52MS/N	238GK54MS/N
208MS	208GD51MS/N	208GD52MS/N	208GD54MS/N	208GK51MS/N	208GK52MS/N	208GK54MS/N
214MS	214GD51MS/N	214GD52MS/N	214GD54MS/N	214GK51MS/N	214GK52MS/N	214GK54MS/N

<sup>1</sup> To be used with All-Guard cartridge holder (80101/N) and column coupler for All-Guard cartridges (HI-081).

<sup>2</sup> Includes holder (80101/N), column coupler (HI-081), and 1 guard cartridge.

**ANALYTICAL COLUMNS - 10 µm**

Length (mm)	250	Guard cartridges (2/pk) <sup>1</sup>	Guard cartridge kits <sup>2</sup>	
i.d. (mm)	1.0	4.6	For 3.0-4.6	For 3.0-4.6
218MS	218MS101	218MS104	218GD104MS/N	218GK104MS/N
208MS	-	208MS104	-	-
214MS	-	214MS104	-	-

<sup>1</sup> To be used with All-Guard cartridge holder (80101/N) and column coupler for All-Guard cartridges (HI-081).

<sup>2</sup> Includes holder (80101/N), column coupler (HI-081), and 1 guard cartridge.

**ANALYTICAL COLUMNS - 10-15 µm**

Length (mm)	250
i.d. (mm)	4.6
214MS	214MS10154

**SEMI-PREPARATIVE AND PREPARATIVE COLUMNS - 5 µm**

Length (mm)	250
i.d. (mm)	10
218MS	218MS510
208MS	208MS510
214MS	214MS510

**SEMI-PREPARATIVE AND PREPARATIVE COLUMNS - 10 µm**

Length (mm)	150	250	
i.d. (mm)	22	10	22
218MS	218MS102215	218MS1010	218MS1022
208MS	208MS102215	-	208MS1022
214MS	-	214MS1010	214MS1022

**SEMI-PREPARATIVE AND PREPARATIVE COLUMNS - 10-15 µm**

Length (mm)	250	Guard cartridges - 12 µm (2/pk) <sup>1</sup>
i.d. (mm)	22	For 22
214MS	214MS101522	214FSK1210MS

<sup>1</sup> To be used with semi-prep guard holder (GCH10) and column coupler for All-Guard cartridges (HI-081).

# Vydac Everest

## for high resolution of complex samples

Vydac Everest columns (238EV) have unique selectivity and sensitivity, which are the result of bonding technology that improves C18 surface coverage and deactivates residual silanols. Leading 300 Å C18 chemistries have had carbon coverage in the 2.8 to 3.6  $\mu\text{mol m}^{-2}$  range. Everest C18 coverage is in excess of 4  $\mu\text{mol m}^{-2}$  and approximates the theoretical limit based on surface area. The increased shielding of the base silica increases column lifetime and reduces the amount of TFA required to

shield the silica.

### Key Features

- Unique selectivity for hydrophilic and hydrophobic peptides
- 300 Å pore size spherical silica
- Excellent sensitivity with little or no TFA in mobile phase
- Ideal for complex enzymatic digests (>12 proteins)

### ORDERING INFORMATION

#### CAPILLARY COLUMNS - 5 $\mu\text{m}$

Length (mm)	50			100	
i.d. (mm)	0.075	0.3	0.5	0.075	0.3
C18	238EV5.07505	238EV5.305	238EV5.505	238EV5.07510	238EV5.310

Length (mm)	150			250
i.d. (mm)	0.075	0.3	0.5	0.3
C18	238EV5.07515	238EV5.315	238EV5.515	238EV5.325

#### ANALYTICAL COLUMNS - 5 $\mu\text{m}$

Length (mm)	50		100		150		
i.d. (mm)	1.0	4.6	2.1	3.0	1.0	2.1	4.6
C18	238EV5105	238EV5405	238EV5210	238EV5310	238EV5115	238EV5215	238EV5415

Length (mm)	250			Guard cartridges (2/pk) <sup>1</sup>		Guard cartridge kits <sup>2</sup>
i.d. (mm)	1.0	2.1	4.6	For 2.1	For 3.0-4.6	For 3.0-4.6
C18	238EV51	238EV52	238EV54	238GD52EV/N	238GD54EV/N	238GK54EV/N

<sup>1</sup> To be used with All-Guard cartridge holder (80101/N) and column coupler for All-Guard cartridges (HI-081).

<sup>2</sup> Includes holder (80101/N), column coupler (HI-081), and 1 guard cartridge.

#### SEMI-PREPARATIVE COLUMNS - 5 $\mu\text{m}$

Length (mm)	250	Guard cartridges (2/pk) <sup>1</sup>
i.d. (mm)	10	For 10-22
C18	238EV510	238GCC510EV

<sup>1</sup> To be used with semi-prep guard holder (GCH10) and column coupler for All-Guard cartridges (HI-081).

#### SEMI-PREPARATIVE COLUMNS - 10 $\mu\text{m}$

Length (mm)	250
i.d. (mm)	22
C18	238EV1022

# Vydac Denali

## for small molecule analyses

Vydac Denali (238DE) is a 120 Å C18 bonded phase with high carbon coverage, suitable for the analysis of both acidic and basic analytes. It has applications for small molecule analyses of interest to pharmaceutical and environmental laboratories.

### Key Features

- High retentiveness
- LC/MS of small molecules
- Fully scalable from capillary to process

### ORDERING INFORMATION

#### CAPILLARY COLUMNS - 5 µm

Length (mm)	50		
i.d. (mm)	0.075	0.3	0.5
C18	238DE5.07505	238DE5.305	238DE5.505

Length (mm)	100	150	250	
i.d. (mm)	0.075	0.075	0.5	0.3
C18	238DE5.07510	238DE5.07515	238DE5.515	238DE5.325

#### ANALYTICAL COLUMNS - 5 µm

Length (mm)	50				100			
i.d. (mm)	1.0	2.1	3.0	4.6	1.0	2.1	3.0	4.6
C18	238DE5105	238DE5205	238DE5305	238DE5405	238DE5110	238DE5210	238DE5310	238DE5410

Length (mm)	150				250		
i.d. (mm)	1.0	2.1	3.0	4.6	1.0	2.1	4.6
C18	238DE5115	238DE5215	238DE5315	238DE5415	238DE51	238DE52	238DE54

Length (mm)	Guard cartridges (2/pk) <sup>1</sup>			Guard cartridge kits <sup>2</sup>		
i.d. (mm)	For 1.0	For 2.1	For 3.0-4.6	For 1.0	For 2.1	For 3.0-4.6
C18	238GD51DE/N	238GD52DE/N	238GD54DE/N	238GK51DE/N	238GK52DE/N	238GK54DE/N

<sup>1</sup> To be used with All-Guard cartridge holder (80101/N) and column coupler for All-Guard cartridges (HI-081).

<sup>2</sup> Includes holder (80101/N), column coupler (HI-081), and 1 guard cartridge.

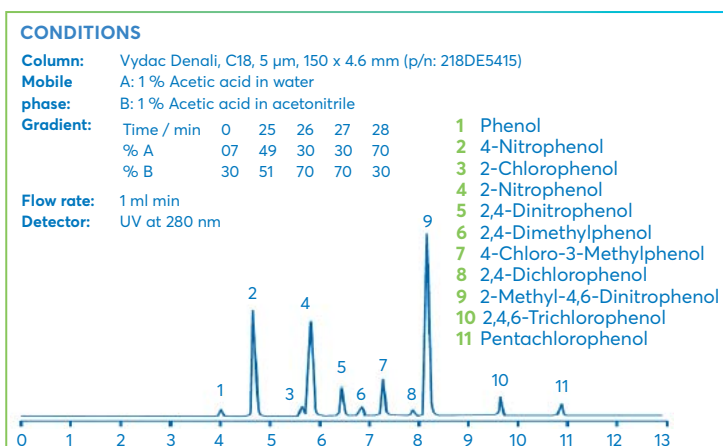

FIGURE 10: EPA 604 Phenols Mixture.

#### ANALYTICAL COLUMNS - 10 µm

Length (mm)	50	150	250	300	
i.d. (mm)	4.6	4.6	4.0	4.6	4.6
C18	238DE10405	238DE10415	DE-10C18-250DF	238DE104	DE-10C18-300DF
Silica	–	–	–	5174066	–

#### SEMI-PREPARATIVE AND PREPARATIVE COLUMNS - 5 µm

Length (mm)	100	150	250	
i.d. (mm)	10	10	22	10
C18	238DE51010	5174053	238DE52215	238DE510
Silica	–	5174054	–	–

#### SEMI-PREPARATIVE AND PREPARATIVE COLUMNS - 10 µm

Length (mm)	150	250	Guard cartridges (2/pk) <sup>1</sup>		
i.d. (mm)	10	22	10	22	For 10-22
C18	238DE101015	238DE102215	238DE1010	238DE1022	238GCC1010DE
Silica	–	5174057	5174063	–	–

<sup>1</sup> To be used with semi-prep guard holder (GCH10) and column coupler (HI-081).



# Vydac 302IC Anion-Exchange

## for environmental analysis

Vydac 302IC is a low capacity anion-exchange (quaternary amine) material based on a high purity 10 µm large pore size silica.

### Key Features

- Well referenced for non-suppressed ion chromatography applications
- Used with standard HPLC systems for analysis of common ions
- Widely used for environmental analysis

### ORDERING INFORMATION

#### ANALYTICAL COLUMNS - 10 µm

Length (mm)	100		250		Guard cartridges (2/pk) <sup>1</sup>
i.d. (mm)	4.6	2.1	4.6		For 4.6
302IC	302IC4610	302IC102	302IC4.6		302GD4/N

<sup>1</sup> To be used with All-Guard cartridge holder (80101/N) and column coupler for All-Guard cartridges (HI-081).

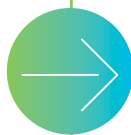

For additional dimensions please contact  
[chromsupport@avantorsciences.com](mailto:chromsupport@avantorsciences.com)

# Avantor<sup>®</sup> HPLC columns

## for Ion chromatography

Ion chromatography techniques allow for the analysis of anions, cations and polar analytes. These columns are more commonly run on polymer materials such as polystyrene divinylbenzene (PSDVB) or polymethacrylate. These materials have different solvent compatibilities which is important to consider when choosing your column.

Within the Avantor Ion chromatography portfolio, there are products available for use with both cation and anion exchange methods. Cation exchange columns with transition metal counterions such as  $\text{Ca}^{2+}$  are also commonly known as ligand exchange columns. These stationary phases are particularly suited to the analysis of carbohydrates and organic acids.

Phase	USP listing	Base material	Functional group	Particle Size ( $\mu\text{m}$ )	pH	Solvent compatibility
<b>Cation exchange</b>						
Avantor <sup>®</sup> Hichrom Organic Acid	L17	Polystyrene divinylbenzene	Sulphonated resin in $\text{H}^+$ form	6.5, 8, 9	0 – 14	100 % aqueous only
Avantor <sup>®</sup> Hichrom Carbohydrate Cation	L19	Polystyrene divinylbenzene	Sulphonated resin in $\text{Ca}^{2+}$ form	10	0 – 14	100 % aqueous only
Avantor <sup>®</sup> Hichrom Anion Exclusion	L22	Polystyrene divinylbenzene	Sulphonated resin in $\text{H}^+$ form	10	0 – 14	Aqueous with <10% MeCN or <5 % IPA or EtAC, no MeOH
<b>Anion exchange</b>						
Avantor <sup>®</sup> Hichrom Allsep Anion	L23	Polymethacrylate	Quaternary ammonium	7	2 – 10	0 – 100 % organic modifier
Avantor <sup>®</sup> Hichrom Anion/S	-	Silica	Quaternary ammonium	10	pH 2 – 5.5	0 – 100 % organic modifier



For additional technical & application support, please contact [chromsupport@avantorsciences.com](mailto:chromsupport@avantorsciences.com)

# Avantor® Allsep Anion

for applications of anions, acid ions, metal complexes and organic acids

Avantor® Allsep Anion is a methacrylate based phase with quaternary ammonium functional groups, optimised for use with both suppressed and non-suppressed conductivity detection. Columns are compatible with common IC mobile phases, such as carbonate, bicarbonate, p-hydroxybenzoic acid, phthalic acid, succinic acid, and sodium octane sulfonate. Avantor® Allsep Anion is recommended for applications involving inorganic anions, weak and strong acid ions, metal complexes and organic acids. It meets the requirements for the EPA method 300.0 Part A for determination of inorganic ions in water.

## Key Features

- 7 µm polymer-based anion exchange phase
- Suppressed or non-suppressed conductivity detection
- pH range 2–10
- Use with 0–100 % organic modifier
- USP L23

## ORDERING INFORMATION

7 µm

Length (mm)	50	100	150	250	
i.d. (mm)	4.6	4.6	2.1	4.6	2.1
Stainless Steel	51214	51200	51210	51208	51212
PEEK (metal-free)	51213	51207	-	51209	-

Length (mm)	Guard cartridges (3/pk) <sup>1</sup>	Guard cartridges (3/pk) <sup>1</sup>	Guard cartridge kits <sup>2</sup>	Guard cartridge kits <sup>2</sup>
i.d. (mm)	For 2.1	For 3.0–4.6	For 2.1	For 3.0–4.6
Stainless Steel	38110/S	38108/S	38111/S	38109/S
PEEK (metal-free)	-	38108	-	38109

<sup>1</sup> All-Guard cartridge holder and coupler (80101/N and HI-081) for stainless steel hardware and 80101 for PEEK hardware required.

<sup>2</sup> Includes All-Guard cartridge holder and coupler (80101/N and HI-081) for stainless steel hardware, 80101 for PEEK hardware, and 3 guard cartridges.

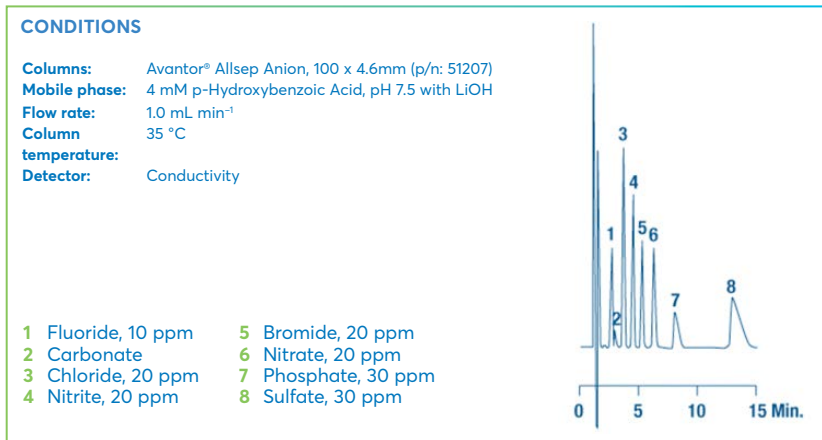

FIGURE 12: Anions with p-HBA Mobile Phase.

# Avantor® Hichrom Anion/S

for non-suppressed conductivity detection and routine separations

Avantor® Hichrom Anion/S columns are based on 10 µm silica with quaternary ammonium ion-exchange groups. These columns are optimised for non-suppressed conductivity detection and are best suited for routine separations of chloride, bromide, nitrate, and sulphate.

### Key Features

- Silica-based for symmetrical peak shapes
- Separates inorganic and organic anions

### ORDERING INFORMATION

10 µm

Length (mm)	100	250
i.d. (mm)	4.6	4.6
Stainless Steel	269013	269001
PEEK (metal-free)	269012	269011

### CONDITIONS

**Column:** Avantor® Anion/S, 100 x 4.6 mm (p/n: 269012)  
**Mobile phase:** 1.5 mM Sulfuric Acid  
**Flow rate:** 1.0 mL min<sup>-1</sup>  
**Detection:** UV at 210 nm

- 1 Nitrite
- 2 EDTA
- 3 Nitrate
- 4 Bromide

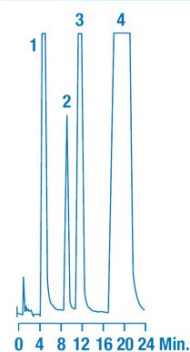

FIGURE 12: EDTA.

# Avantor® Hichrom pre-saturation columns

All Avantor® silica HPLC packing materials will gradually dissolve in aqueous solution. This problem is exacerbated when the pH level of the solution is above 7. To avoid silica dissolution, mobile phases should ideally be buffered between pH 3.5–6.5. Where high levels of aqueous solvent or alkaline pH conditions are

required, the pre-saturation column (packed with large 40 µm particle diameter silica) saturates the mobile phase with silica to minimise analytical column dissolution problems.

### ORDERING INFORMATION

#### PRE-SATURATION COLUMNS

Description	Pk	Cat.No
Avantor® Hichrom pre-saturation column, 250 x 4.6 mm	1	28610
Avantor® Hichrom pre-saturation column, 250 x 4.6 mm	4	28650

# Avantor® Hichrom Organic Acid

## for separation of organic acids

Avantor® Hichrom Organic Acid columns are ion exclusion columns packed with sulphonated polystyrene-divinylbenzene. The OA-1000 and OA-2000 columns exhibit excellent selectivity for aliphatic and aromatic acids. As with most ion exclusion columns, a column heater is necessary for normal operating procedures. The IOA-1000 and IOA-2000 columns are suitable for the separation of citric and other acids from glucose and fructose.

### Key Features

- Rapid analysis of organic acids and alcohols
- pH stable polymer resin
- Isocratic 100 % aqueous mobile phases only - no organic solvents
- USP L17
- Sulphonated polystyrene divinylbenzene resin (H<sup>+</sup> form)

### ORDERING INFORMATION

#### AVANTOR® HICHROM ORGANIC ACID

Part number	Phase	Particle size (µm)	Column dimensions (mm)	Applications
9046	OA-1000	9	300 x 6.5	Inorganic ions, such as fluoride, arsenate, sulphite, alcohols and most organic acids
9048	OA-2000	6.5	100 x 6.5	Organic acids with low pH values, low MW straight chain acids and aromatic acids
9646	IOA-1000	9	300 x 7.8	Acids of the tricarboxylic acid cycle (Krebs cycle)
9648	IOA-2000	8	150 x 6.5	Fast separation of acids and some alcohols

Description	Pk	Cat.No.
Guard cartridges for Hichrom Organic Acid columns	2	28884
Guard cartridge kit for Hichrom Organic Acid columns, including guard cartridge holder and 2 guard cartridges	1	28883

### CONDITIONS

**Columns:** Avantor® Hichrom OA-2000, 6.5 µm, 100 x 6.5 mm (p/n: 9048)  
**Mobile phase:** 0.01 M Sulfuric Acid  
**Flow rate:** 0.8 mL min<sup>-1</sup>  
**Column temperature:** 45 °C  
**Detector:** UV at 228 nm

- 1 Oxalic Acid
- 2 Citric Acid
- 3 Shikimic Acid
- 4 Fumaric Acid
- 5 Butyric Acid
- 6 Homoprotocatechuic Acid
- 7 Gallic Acid
- 8 Protocatechuic Acid
- 9 Gentisic Acid
- 10 p-Hydroxybenzoic Acid
- 11 Benzoic Acid
- 12 Salicylic Acid

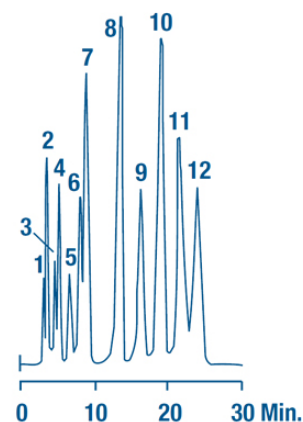

FIGURE 13: Short-Chain Aromatic Carboxylic Acids.



For technical enquiries, please contact  
[chromsupport@avantorsciences.com](mailto:chromsupport@avantorsciences.com)

# Avantor® Hichrom Anion Exclusion

## for separation of organic acids and ionised anions

Avantor® Hichrom Anion Exclusion columns are based on a highly sulphonated polystyrene-divinylbenzene cation-exchange resin. The phase has a particle size of 10 µm and is designed for the separation of organic acids and weakly ionised anions by an anion exclusion mechanism. Typical mobile phases contain dilute mineral acids. Acetonitrile (<10%) may be added as organic modifier to decrease the retention of hydrophobic compounds.

### Key Features

- Separates organic acids and weakly ionised anions
- Polymer-based for broad pH stability
- USP L22
- Sulphonated polystyrene divinylbenzene resin (H<sup>+</sup> form)

### ORDERING INFORMATION

#### AVANTOR® HICHROM ANION EXCLUSION - 10 µm

Length (mm)	100	300
i.d. (mm)	7.8	7.8
Anion Exclusion (stainless steel)	269068	269006

### CONDITIONS

**Column:** Avantor® Hichrom Anion Exclusion, 10 µm  
**Dimensions:** 300 x 7.8 mm  
**Mobile phase:** 0.003NH<sub>2</sub>SO<sub>4</sub>  
**Flow rate:** 0.50mL/min  
**Detection:** Conductivity  
**Sensitivity:** 50µS  
**Temperature:** 22 °C

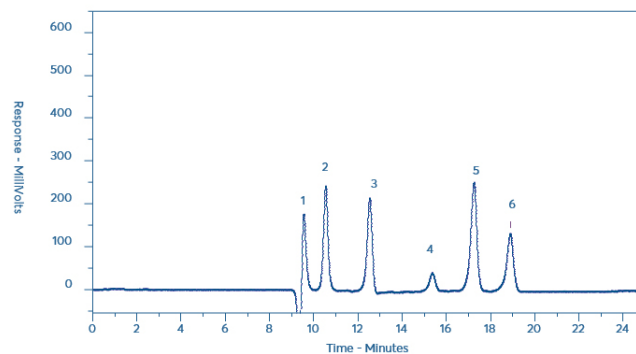

1 Oxalic Acid      4 Succinic Acid  
 2 Maleic Acid     5 Formic Acid  
 3 Malic Acid      6 Acetic Acid

FIGURE 14: Avantor® Hichrom Anion Exclusion.

# Avantor<sup>®</sup> Hichrom Carbohydrate Cation – for separations using only water

Avantor<sup>®</sup> Hichrom Carbohydrate Cation column consists of a highly efficient sulphonated polystyrene resin supplied in the calcium form. This column provides excellent separations of carbohydrates using only water as the mobile phase.

## Key Features

- Sulphonated polystyrene resin (Ca<sup>2+</sup> form)
- 100% water used as mobile phase
- Column heating required
- USP L19

## ORDERING INFORMATION

### HICHROM CARBOHYDRATE CATION

Length (mm)	300
i.d. (mm)	6.5
Hichrom Carbohydrate Cation, 10 µm, 300 x 6.5 mm	70057

## CONDITIONS

**Column:** Avantor<sup>®</sup> Hichrom Carbohydrate Cation, 10 µm, 300 x 6.5 mm (p/n: 70057)  
**Mobile phase:** Water  
**Column temp:** 90 °C  
**Flow rate:** 0.5 mL min<sup>-1</sup>  
**Detection:** ELSD

- 1 Unknown
- 2 Sucrose
- 3 Glucose
- 4 Fructose
- 5 Sorbitol

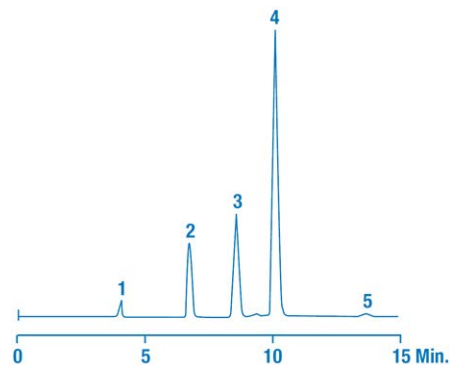

FIGURE 15: 100% Pure Red Delicious Apple Juice (a 1:250 Dilution).



# Guard cartridge systems

Avantor® recommends the use of guard cartridges for analytical column protection and increased column lifetime. The hardware of the All-Guard Cartridge System offers a robust option for high efficiency separations.

**Benefits of the hardware improvement include:**

- Higher pressure rating
- Low internal swept volume

**ORDERING INFORMATION**

**ACCESSORIES**

Description	Cat.No.
All-Guard cartridge holder	80101/N
Column Coupler for All-Guard Cartridge Holder (standard column port)	HI-081
Column Coupler for All-Guard Cartridge Holder (Waters type column port only)	HI-881
Semi-prep guard holder (for 10-22 mm i.d. columns)	C-1000
Vydac semi-prep guard holder (for 10-22 mm i.d. columns)	GCH10
Analytical Guard Holder Wrench Set - contains a pair of 9/16" stainless steel wrenches	HI-226
PEEK Fingertight Fittings (10/pack) - suitable for connection of HPLC columns and guard holders to all 1/16" tubing types, are compatible with both standard and Waters port designs, and are slip free to >5,000 psi	HI-050X

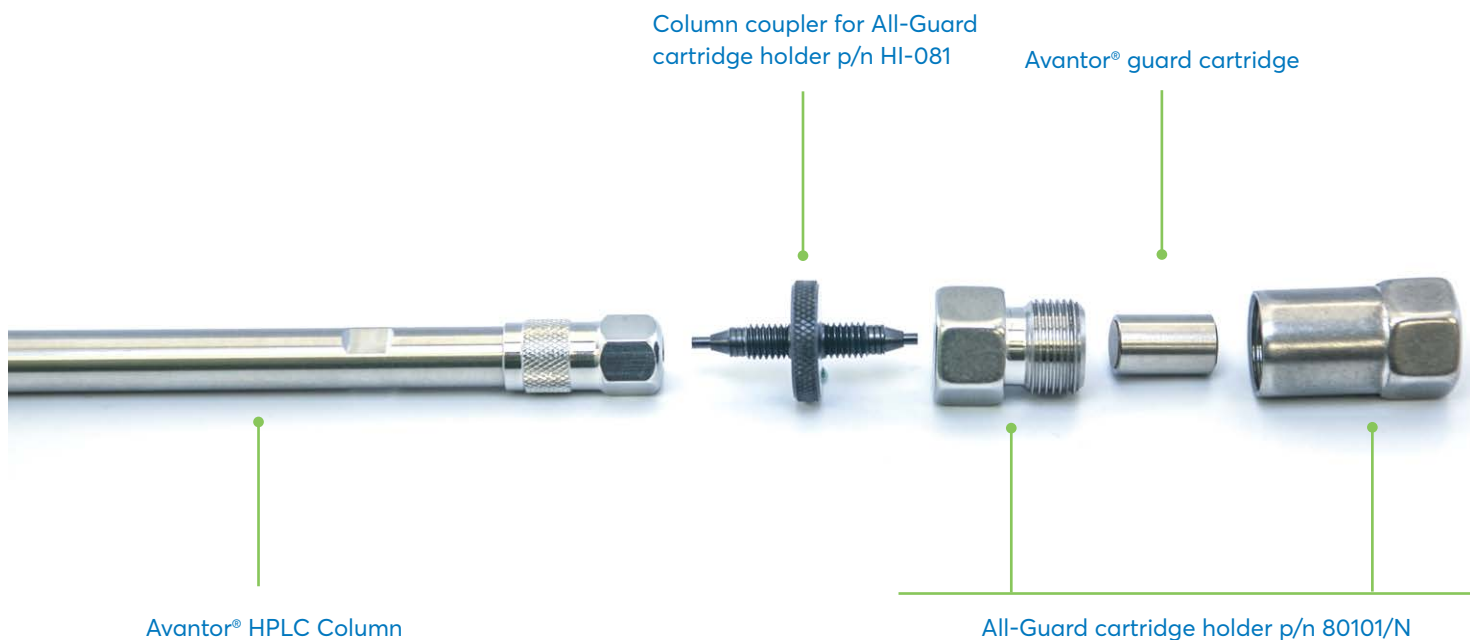

For more info, please contact our Chromatography Technical Specialists at: [chromsupport@avantorsciences.com](mailto:chromsupport@avantorsciences.com)



authorized  
channel partner